

CHANGEOVER SOLUTIONS

制药行业



CHANGEOVER SOLUTIONS

PHARMACEUTICAL INDUSTRY

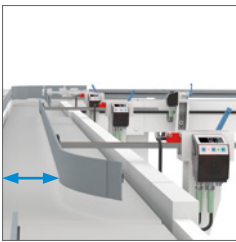

我们提高您的制造机器的效率和生产质量

我们为制药行业的机器制造商和最终用户提供高智能定位系统。我们提供的全监控式位置显示器和全自动化定位执行驱动器使格式更换显著**快捷**，**100% 工艺可靠**并可执行**数字式记录**。

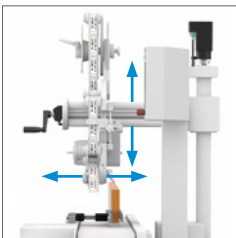

您的优势:

- 制造成本降低优化
- 可追溯性
- 生产质量优化提高
- 也可为现有机器系列提供**更新改造**

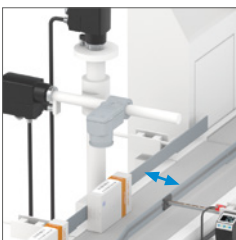

We increase the efficiency and production quality of your machines

*We offer intelligent positioning systems for machine manufacturers and end users in the pharmaceutical industry. Our monitored position indicators and fully automated positioning drives make format changes significantly **faster**, with **100% process reliability** and **digital protocolling**.*

Your advantages:

- *Production cost optimization*
- *Traceability*
- *Quality optimization of your production*
- *Also as **Retrofit** for already existing machinery*

高效可靠

格式调整

用于制药行业

EFFICIENT & SAFE

FORMAT ADJUSTMENT

IN THE PHARMA INDUSTRY



医药产品的制造需要提供极高的生产效率和工艺可靠性。基于生产系统必须提供的产品灵活性，机器能够迅速且无差错地进行格式转换是非常重要的。格式调整是生产过程中决定性的组成部分，SIKO 为此提供以下解决方案。

The manufacture of pharmaceutical products requires an extraordinarily high degree of efficiency and safety in the manufacturing process. Due to the required flexibility of the production plants, it is important to be able to implement a quick and error-free changeover of machines. Format adjustment is a crucial component here, and SIKO provides the following solutions.

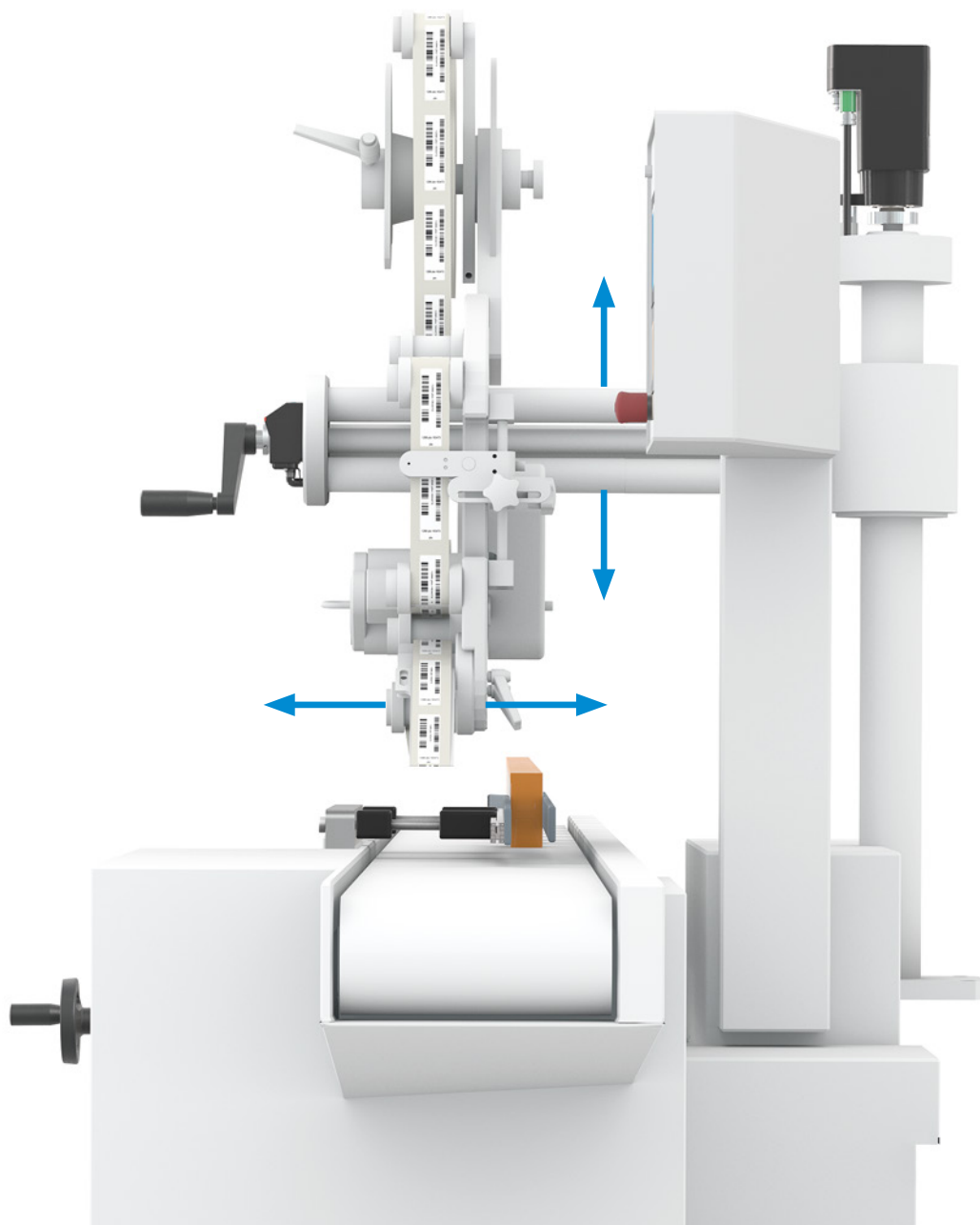

监视控制

格式调整

MONITORED

FORMAT ADJUSTMENT



装盒分配机

包装单元的成型和填充过程必须迅速进行，由于较长时间的调整过程而造成的时间浪费在这里起反作用，由于该工艺过程的高循环率，不完全正确的工作调整还导致高废品率。

Cartoning Machine

The process of erecting and filling packaging units must be carried out quickly. Time losses due to long change-over processes have a counterproductive effect here. Failures during changeover also result in a high scrap rate due to the high cycle rate in this manufacturing process.

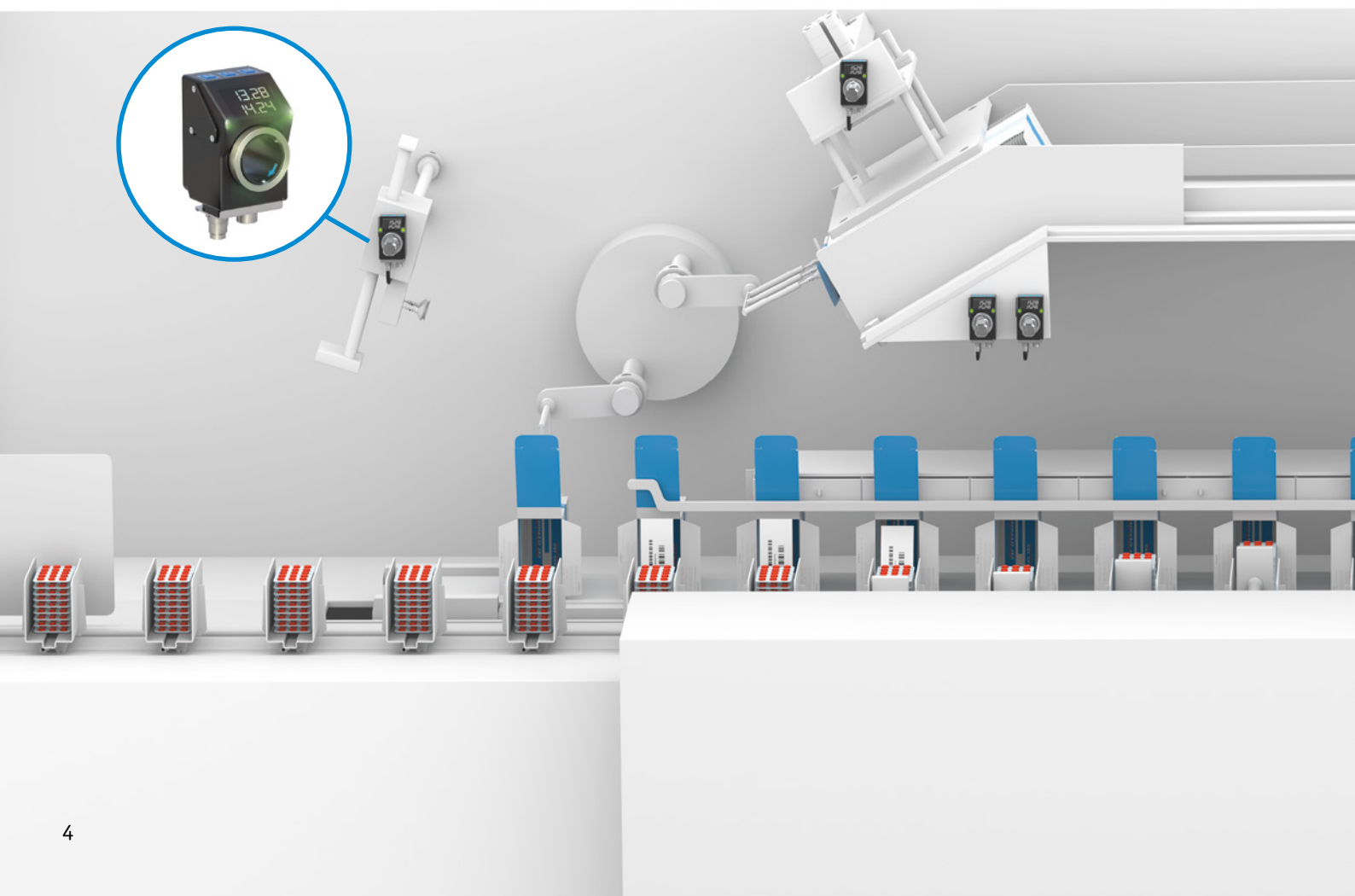

带兼容总线的位置显示器监视手动调整，并通过总线通讯直观地报告错误。因此，开始生产时可能出现的错误的格式设置 100% 被排除在外。显示状态的 LED 灯和方向指示灯使操作员更容易进行快速而精确的格式设置。

Bus-capable position indicators monitor manual adjustment and report errors visually and via bus communication. A production start with an incorrect format setting is therefore 100% excluded. Status LEDs and direction indicators allow for fast and precise setup.

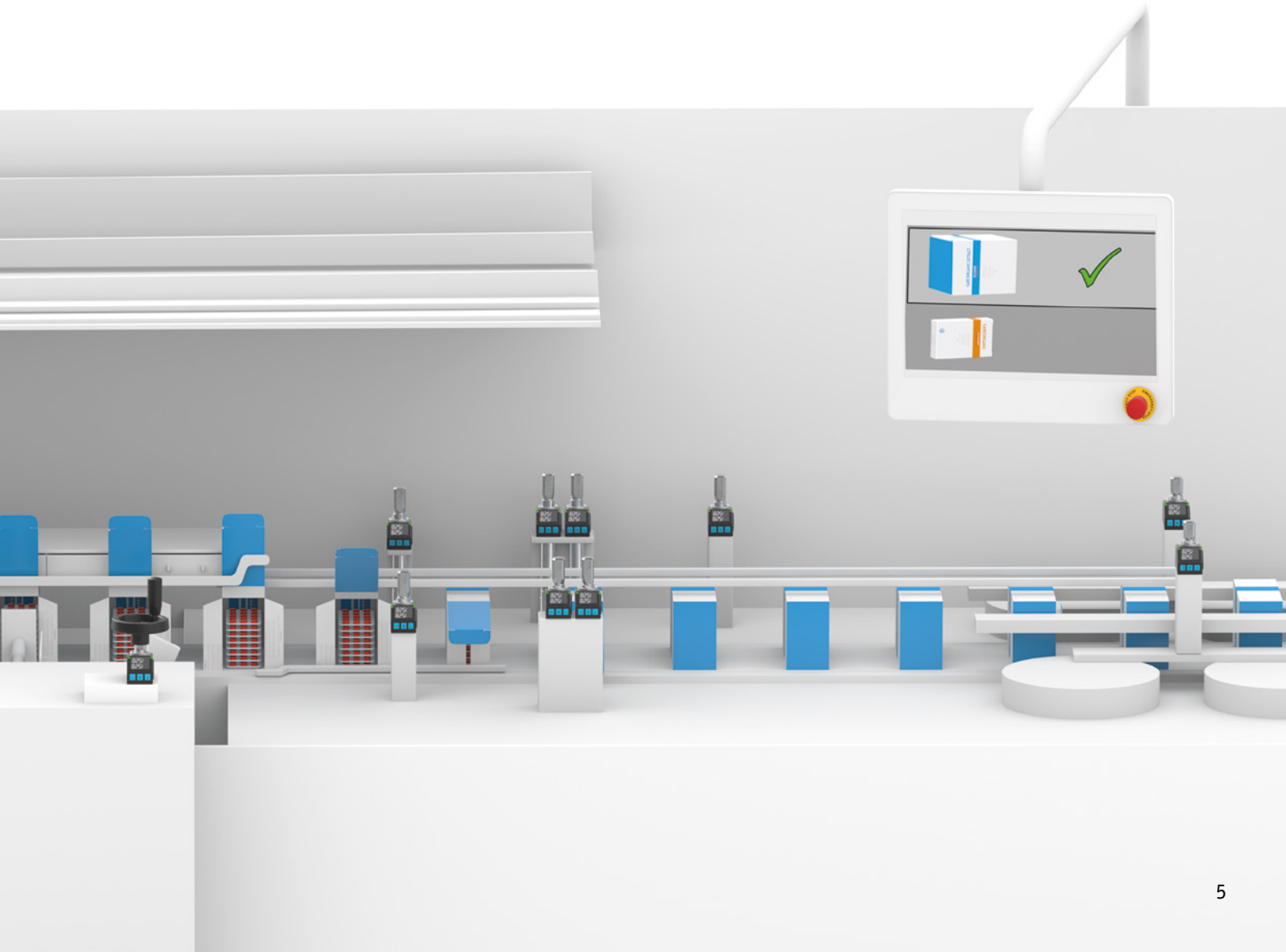
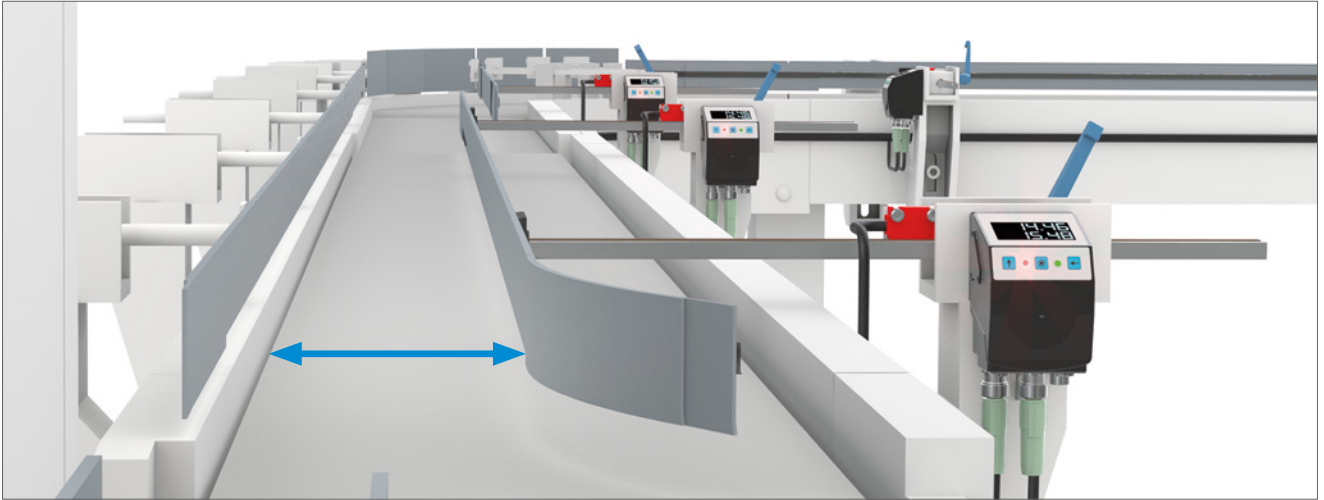

自动化

格式调整

AUTOMATED

FORMAT ADJUSTMENT



紧凑型执行驱动器取代了手动调整的功能，实际上只需按一下按钮即可更改格式。是更快且更可靠地进行格式更换的最佳方式。

Compact actuators replace manual adjustment and enable format change practically at the touch of a button. A format change cannot be implemented more quickly and safely.

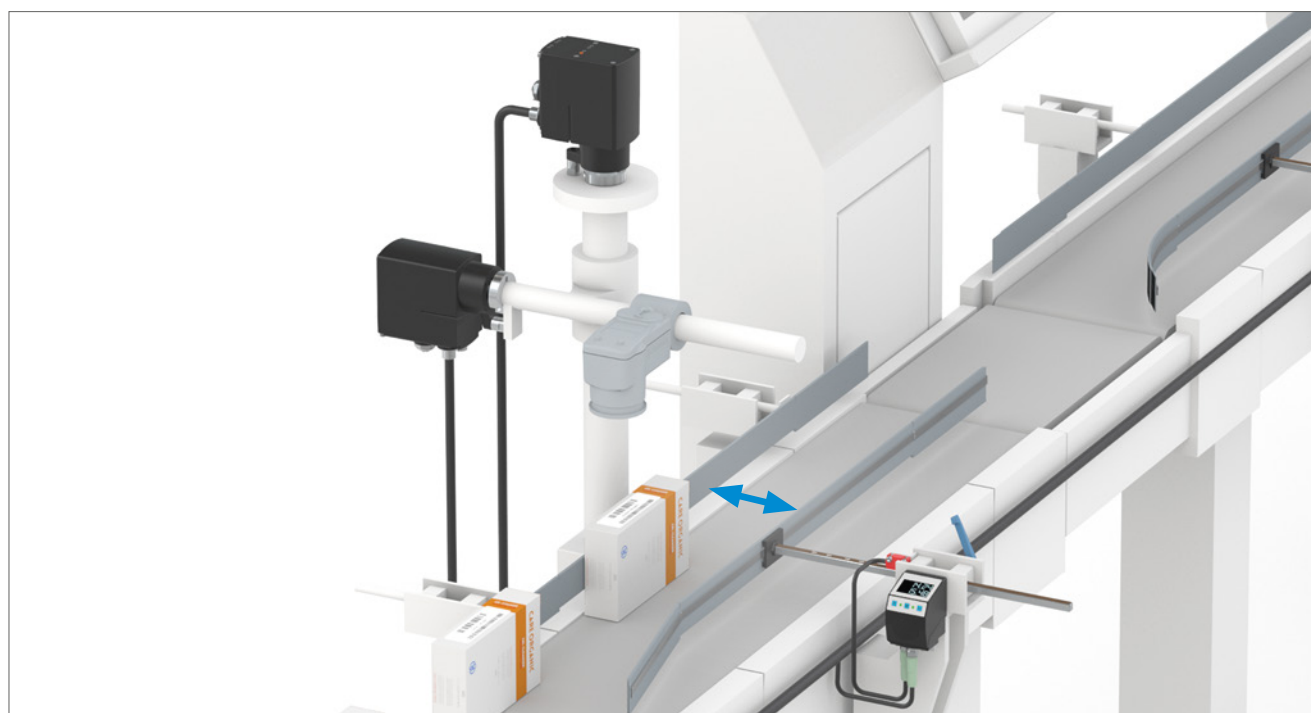

根据纸箱规格快速可靠地调整纸箱架。根据包装盒的大小及其材料的性质，必须快速可靠地调整相应的调节轴。只需按下按钮，紧凑型执行驱动器即刻移动到新的轴位置，自动实现适配下一个包装盒尺寸的调整，并具备 100% 的过程执行可靠性。

Quick and safe conversion of the magazine for the folding boxes. Depending on the packaging size and material quality, the respective adjustment axes must be changed safely and quickly. Compact actuators move to the new axis positions at the touch of a button. The next packaging size is implemented automatically and 100% process-reliable.

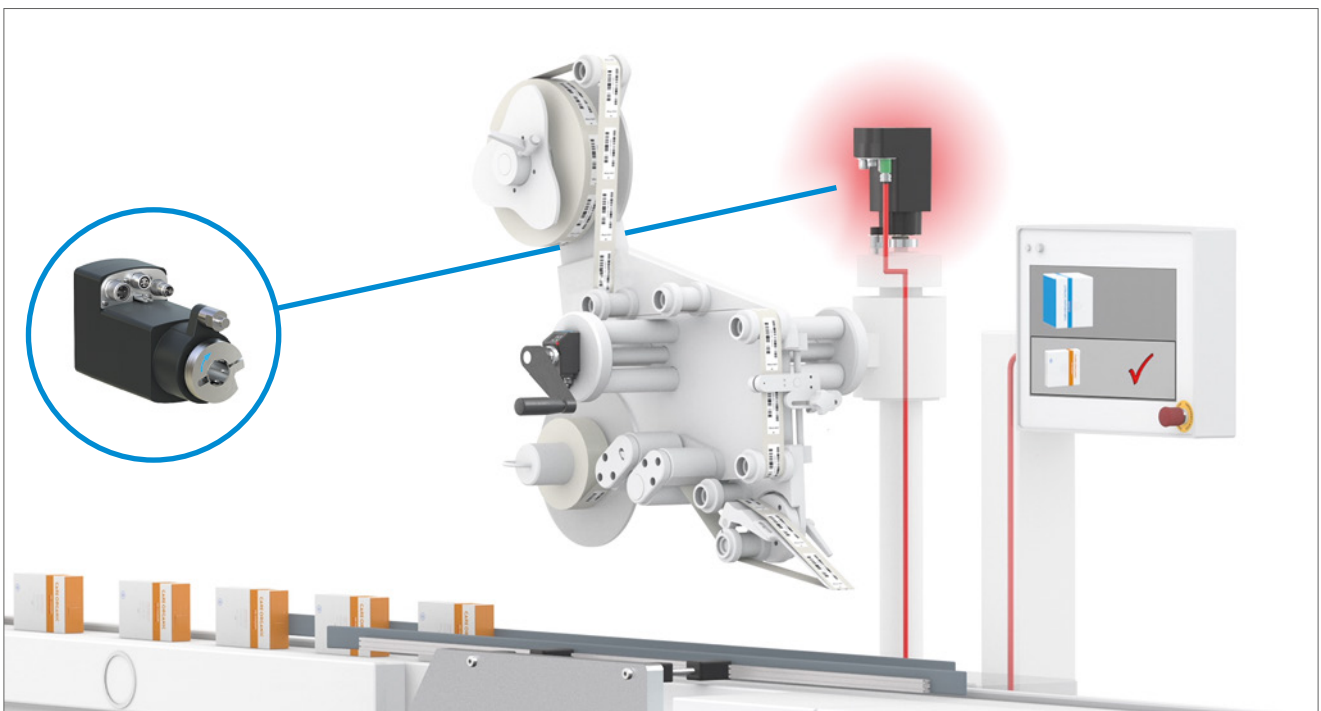
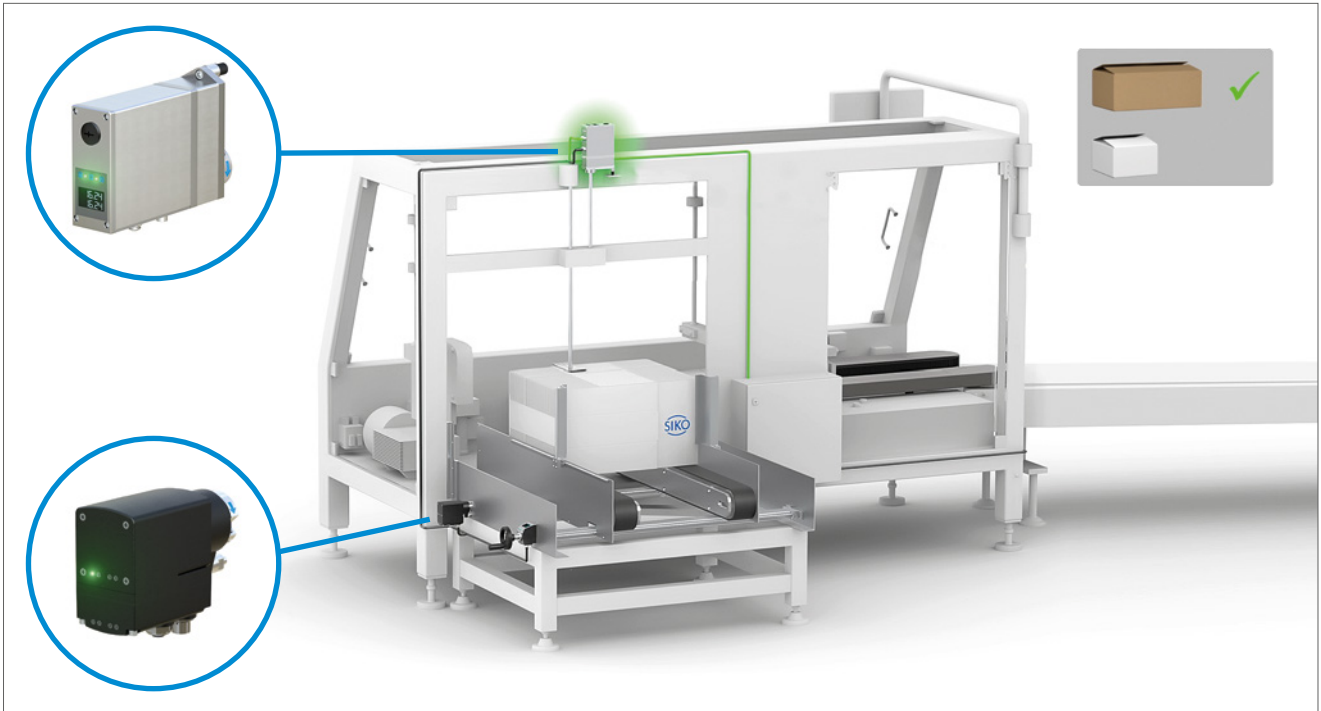

粘贴标签 / 打造标记

在系列产品生产的跟踪序列过程中，对标签和检查任务的要求已大大增加。每次产品规格更改和格式调整后，也必须确保标签打造在新包装上时，正确对齐。否则，后道检测设备将无法正确识别带有序列号的产品。

Labeling / Marking

In the course of serialization and track & trace, the requirements for labeling and inspection have increased immensely. Even with format adjustments, it must be ensured every time the product is changed that the labeling is also correctly aligned for the next repackaging. Otherwise, the subsequent test device can no longer correctly identify the product with serial number.

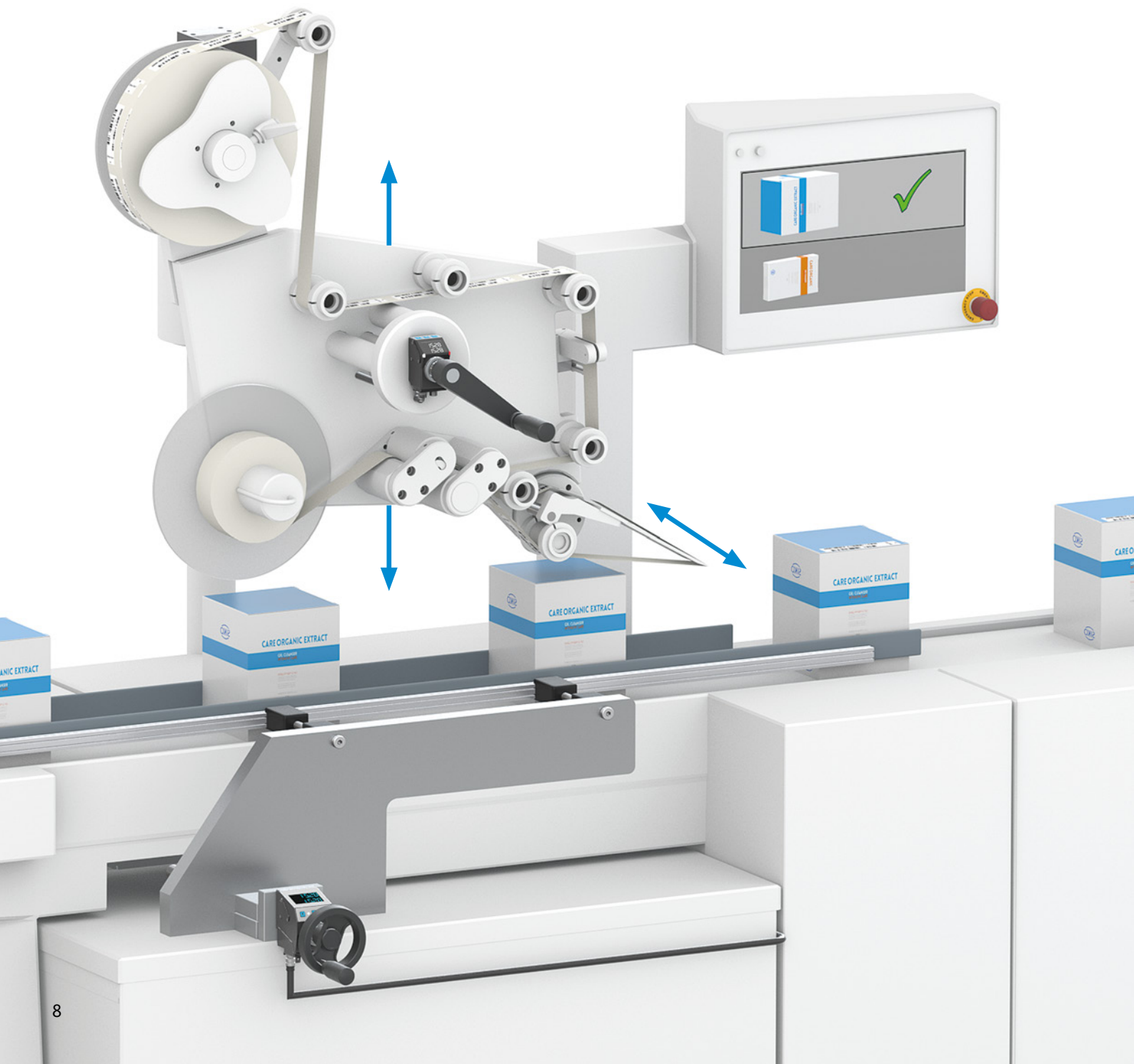

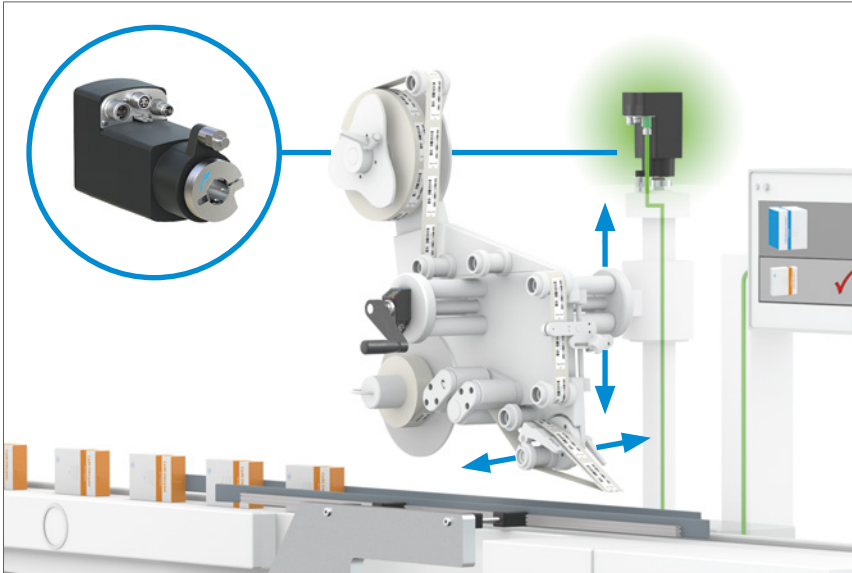

根据包装盒尺寸规格，执行驱动器快速可靠地确保贴标模块的高度。

Actuators ensure fast and safe height adjustment of the labeling module according to the size of the packaging.

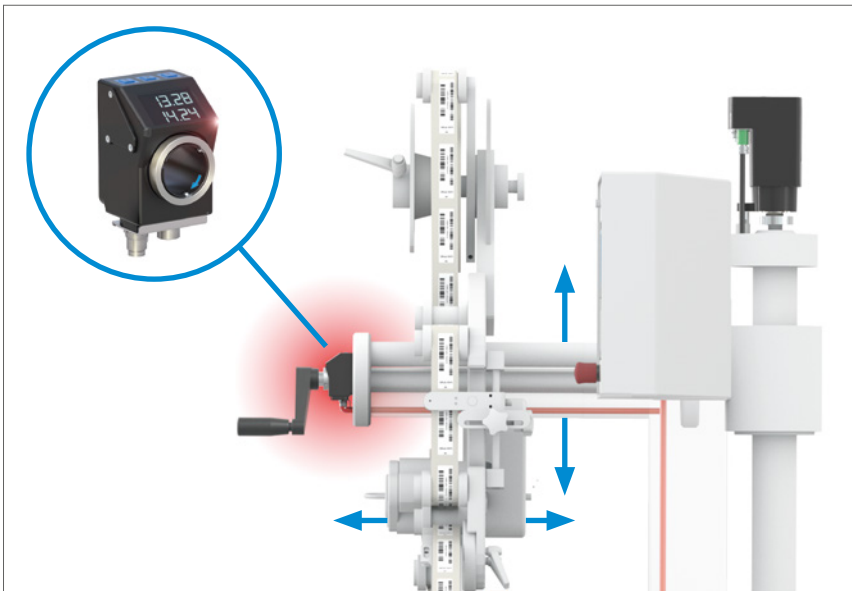

通过电子位置显示器，可高效可靠地进行标签过程的水平定位。

Horizontal positioning of the labeling process is carried out safely and efficiently via electronic position indicators

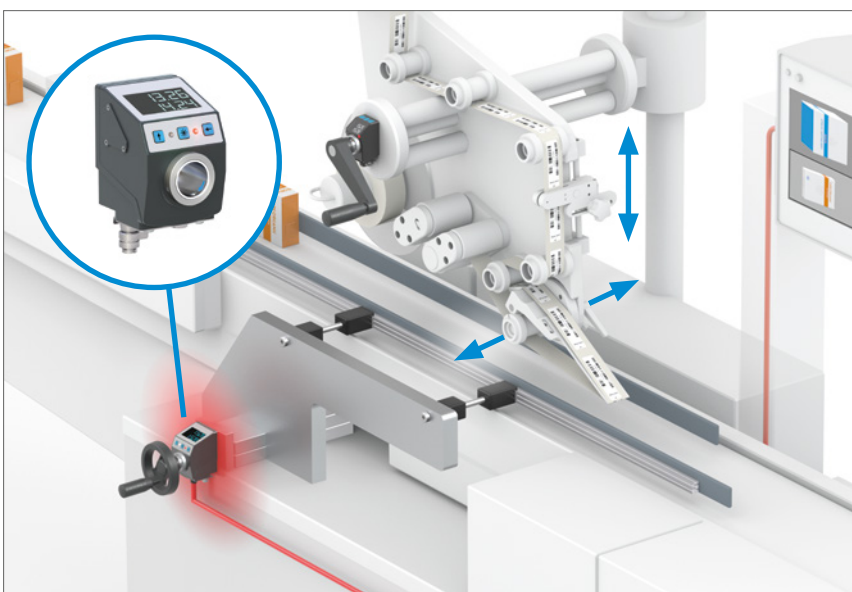

通过监控式格式调整，传送带也将根据新包装盒格式进行调整。

The side guides are set up via monitored format adjustment in accordance with the new packaging format.

产品检验与运输

对各产品进行类型和序列号鉴定是制造过程序列化的关键部分。每次更换产品后，必须根据新的外包装更新检测系统。此处出现的错误将中断对产品序列的跟踪。

Inspection & Transportation

Identification of the product by type and serial number is a decisive process within the serialization of the manufacturing process. After each product change, the detection systems must be adjusted according to the new packaging size. An error would interrupt the tracking of serialization here.

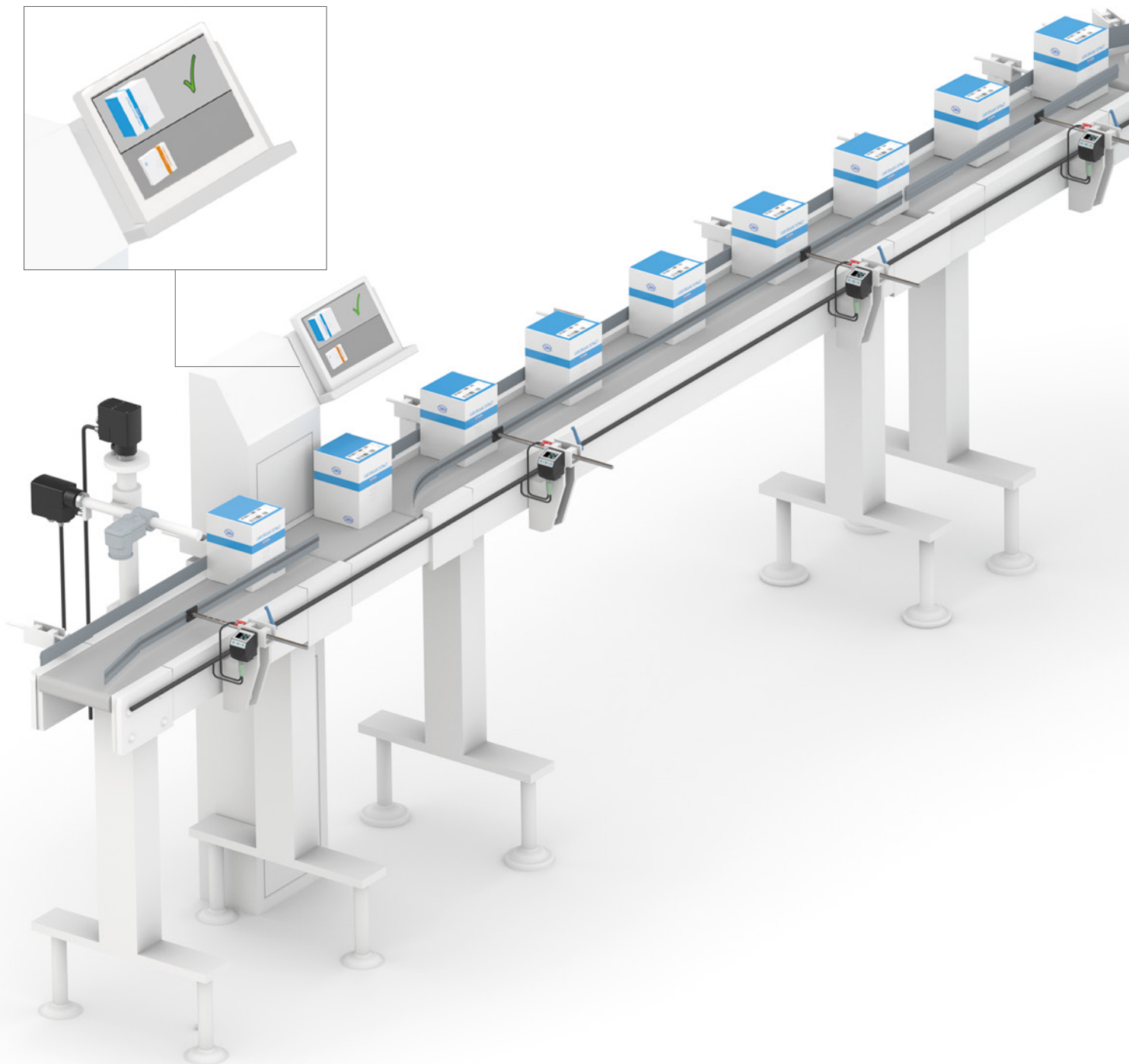

通过执行驱动器可将摄像头在水平和垂直方向对准产品，以记录其标识打造。

The camera is set horizontally and vertically via actuators to detect product labeling.

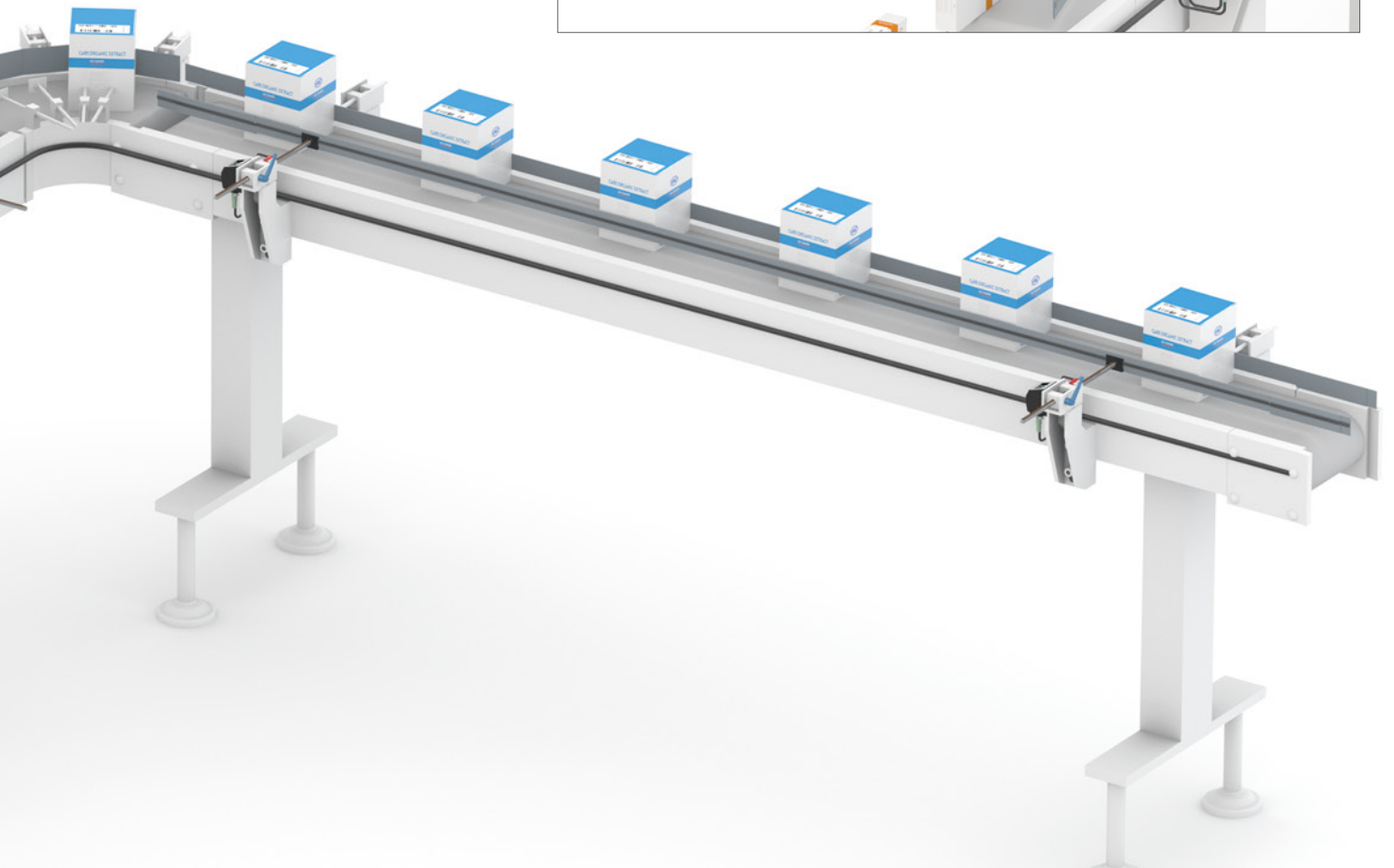
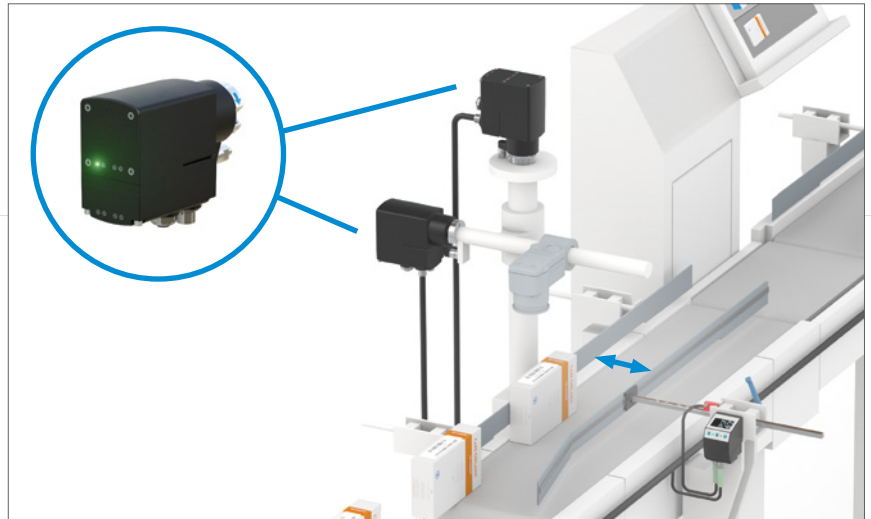

传送带侧向的线性调整适配相应的包装产品规格。通过控制系统的监控，可防止通过可能发生的错误操作而导致的堵塞和废品。

The linear adjustment of the side guides of the conveyor belts is adapted to the respective packaging formats. Monitoring via the control unit prevents material jams and scrap in the event of possible incorrect operation.

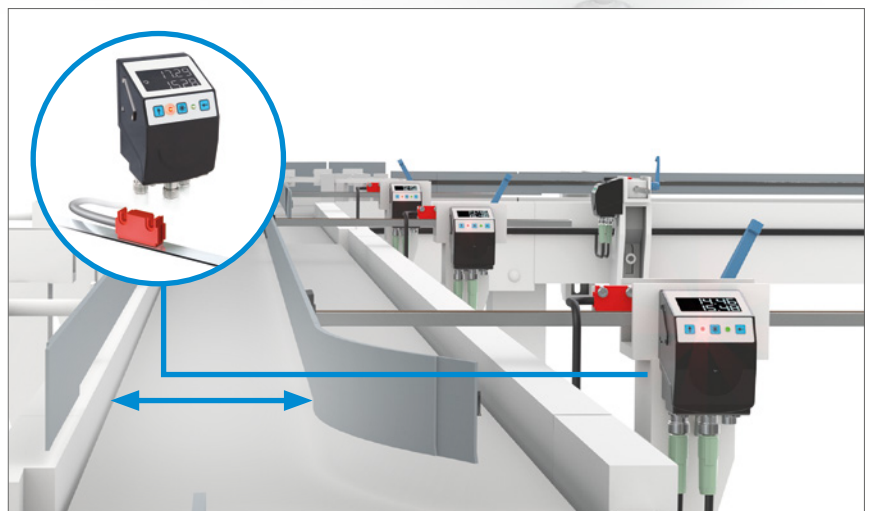

纸箱准备机

在包装工艺线的每次包装产品更换过程中，对整个工艺区域进行快速可靠的格式调整是必不可少的。执行驱动器和电子式位置显示器在此为产品包装规格的快速无误转换提供前提。

Case erector

In the end-of-line packaging process, fast and reliable changeover of the area is essential for every product change. Here, too, actuators and electronic position indicators enable fast and error-free changeover for the new product.

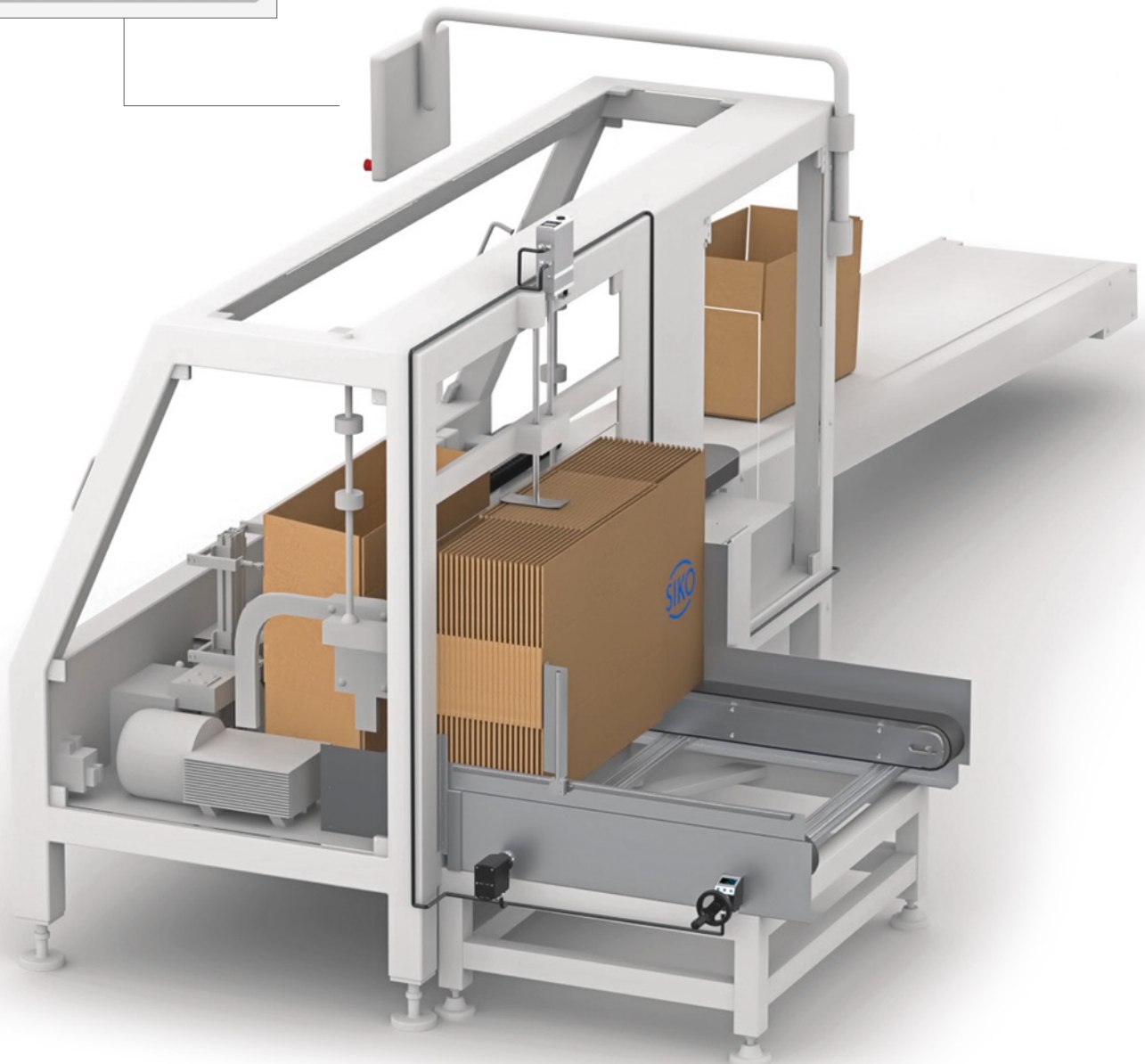

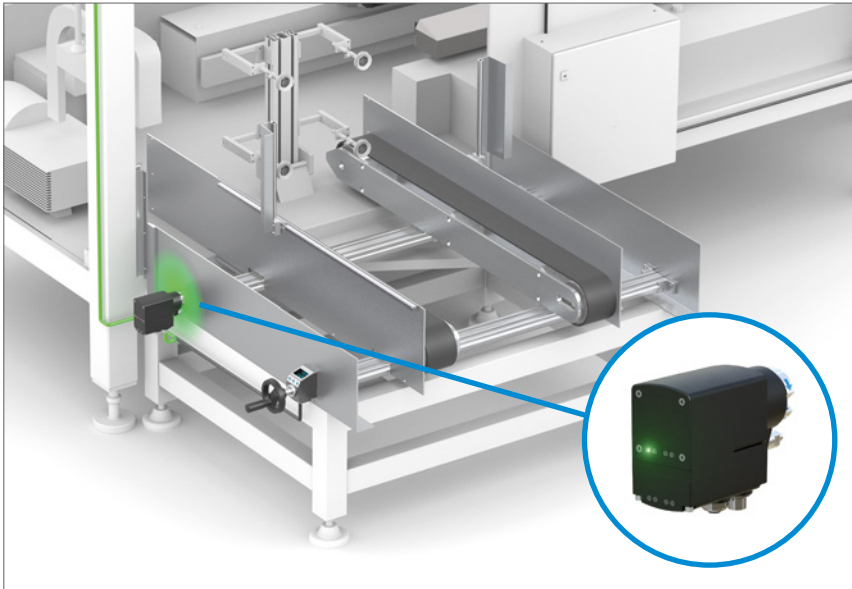

实际上只需按一下按钮，执行驱动器即可调节新包装单元的宽度

The actuator adjusts the width of the new packaging unit practically at the touch of a button.

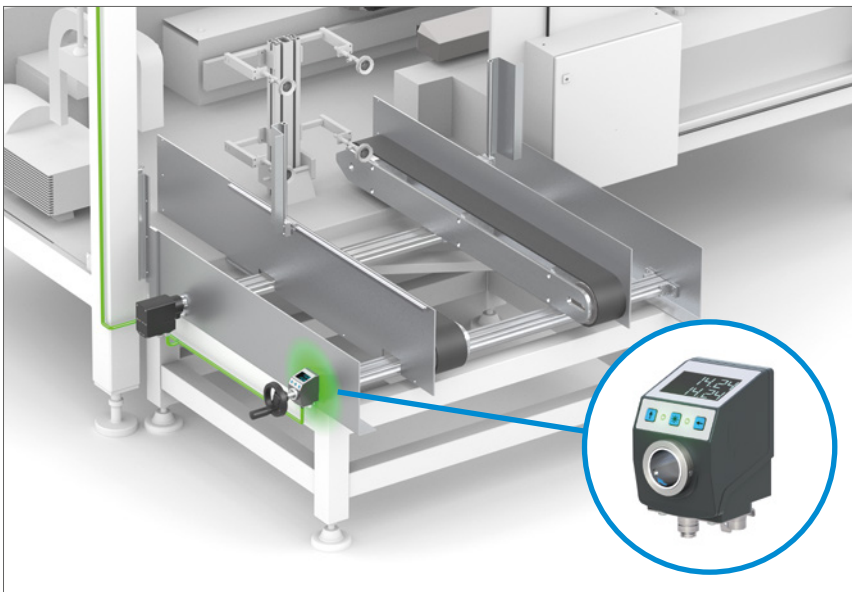

通过电子位置显示器，可精确可靠地确定设置纸箱架的中心。

The centering of the magazine is adjusted precisely and reliably via the electronic position display.

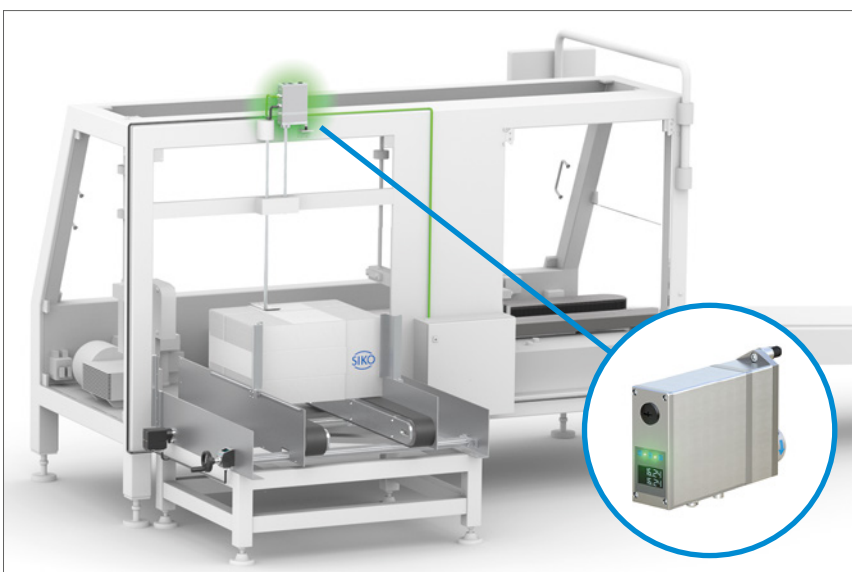

纸箱架的高度调节由执行驱动器自动进行。由于调节单元位置很高，不便手动操作。

The height of the cardboard magazine is adjusted automatically via an actuator. Poor access to the adjusting unit would only permit manual adjustment with high effort.

我们的解决方案

格式调整

OUR SOLUTIONS

FOR THE FORMAT ADJUSTMENT

SIKO 电子式位置显示器使手动格式转换100%可靠并使操作人员直观理解:

Manual format changeover is 100% process-safe and intuitive for the operator with electronic SIKO position indicators:

- 对主轴或滑尺的绝对位置检测
 - 现代化通讯接口方式
 - 通过磁性扫描检测使传感器坚固耐用
 - 利用 LED 状态灯进行用户指南
- *Absolute position detection of spindle or linear slider*
 - *Modern communication interfaces*
 - *Robust sensor technology thanks to magnetic scanning*
 - *User guidance via status LEDs*



- IO-Link
- PROFINET
- EtherNet/IP ODVA
- EtherCAT
- ETHERNET POWERLINK
- CANopen

为了进一步减少设置时间或在难以靠近的地方进行主轴调整 - 使用 SIKO 紧凑型执行驱动器进行自动格式调整，以实现精确和全自动的位置定位。

For further reduction of setup times or for spindle adjustments at inaccessible locations - automated format adjustment with SIKO compact actuators for precise and fully automatic positioning.

- 周期时间或转换时间短
- 高生产率和高质量
- 安装和组装工作异常少
- 运行调试速度快
- 高待用性 / 免维修性

- Short cycle or changeover time
- High level of productivity and quality
- Very little installation and assembly effort
- Fast commissioning
- High availability and maintenance-free

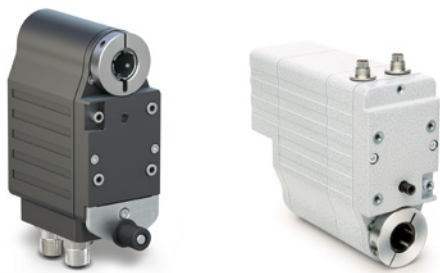

 IO-Link

 PROFINET

 EtherNet/IP
ODVA

 EtherCAT

 ETHERNET
POWERLINK

 CANopen

更新改造

简单直观

RETROFIT

SIMPLE & INTUITIVE

提供源自一手的完整系统!

Retrofit更新改造既适合用作为监视式手动格式调整也适合用作为仅需按一下按钮的自动式格式调整进行更新。运行调试实际上是通过即插即用进行，不需要进行源代码编程。借助SIKO-Retrofit 功能，我们为您提供独立运行的控制系统，用于总线兼容的 SIKO 位置显示器和执行驱动器。直观的用户界面使操作使用变得轻而易举!

A complete system from a single source!

Retrofit as a retrofit option for manual format adjustment as well as monitored format adjustment or automatic conversion at the touch of a button. Commissioning is done practically via plug-and-play. Source code programming is not necessary. With SIKO- Retrofit, we provide you with a self-sufficient control system for bus-capable SIKO-position indicators and actuators. The intuitive user interface makes operation child's play!



消耗时间的经典手动式格式调整

Classic, time-consuming format changeover by hand





通过即插即用方式完成整体改造

Complete retrofit via plug-and-play

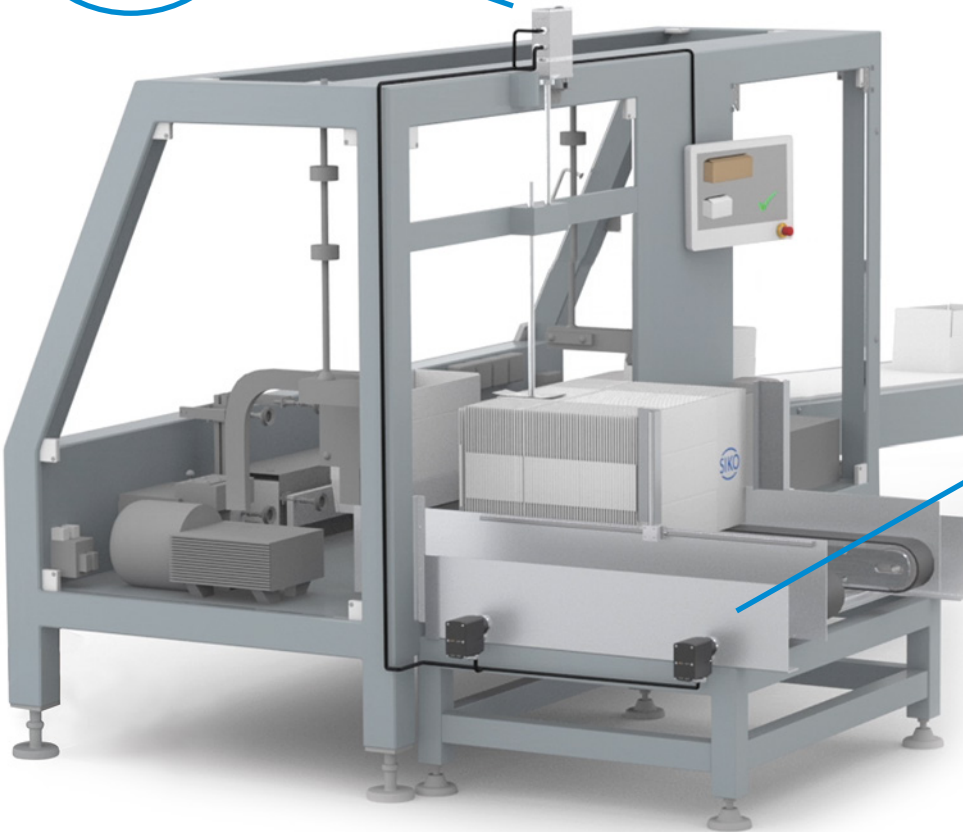
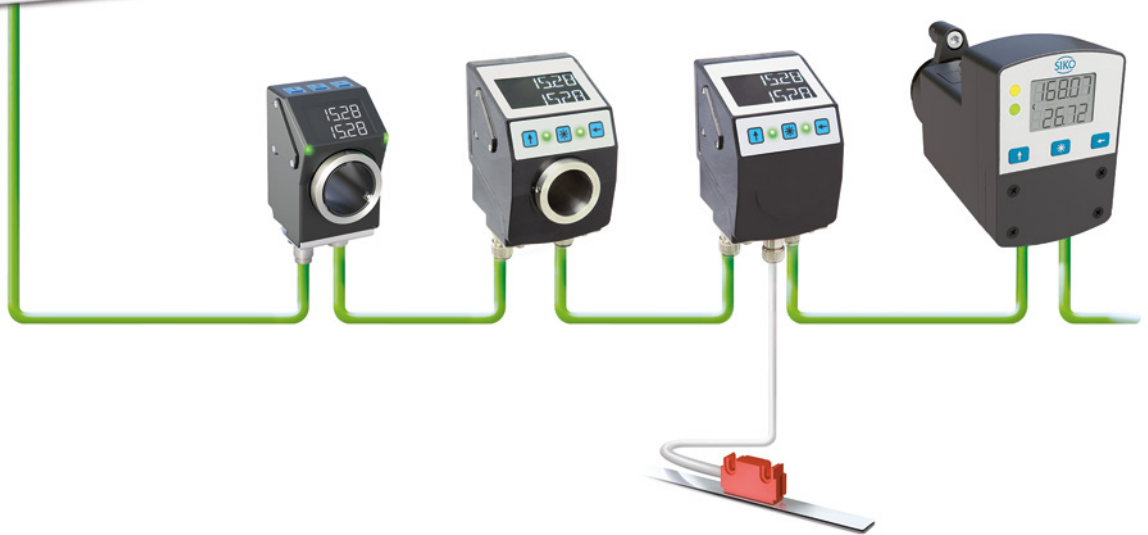

只需按一下按钮即可进行自动调整格式

Automatic format changeover at the push of a button

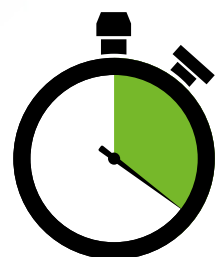

优势列表

Advantage matrix



技术项目 | Engineering

运行调试 Setup	++	+	0
构体增添兼容性 Compatible mounting dimensions	++	++	+ / ++
全体空心轴 Through hollow shaft	++	++	+ / ++
数字式记录性 - 可追溯性 (Traceability) Digital protocolling - Traceability	0	++	++
制造过程可重复性 Reproducibility	0	++	++
兼容现场总线性 Fieldbus-compatible	0	++	++
系统工作精度 System accuracy	0	+	+

经济性 | Cost effectiveness

工艺流程优化 Process optimization	0	+	++
初始成本 Initial cost	++	+	0
折旧 Amortisation	0	+	++

0 = 满意 / 无数据 + = 良好 ++ = 优秀 | 0 = satisfactory/not applicable, + = good, ++ = very good

通过减少停机时间提高机器效率

对工作质量的要求和轴定位的频率越高，通过使用监控式或自动定位的解决方案来提高生产效率和利润的可能性也越高。

Greater machine efficiency through reduced downtimes

The higher the quality requirements and the more often an axis has to be positioned, the greater the productivity and profits will be using a monitored or automated positioning solution.

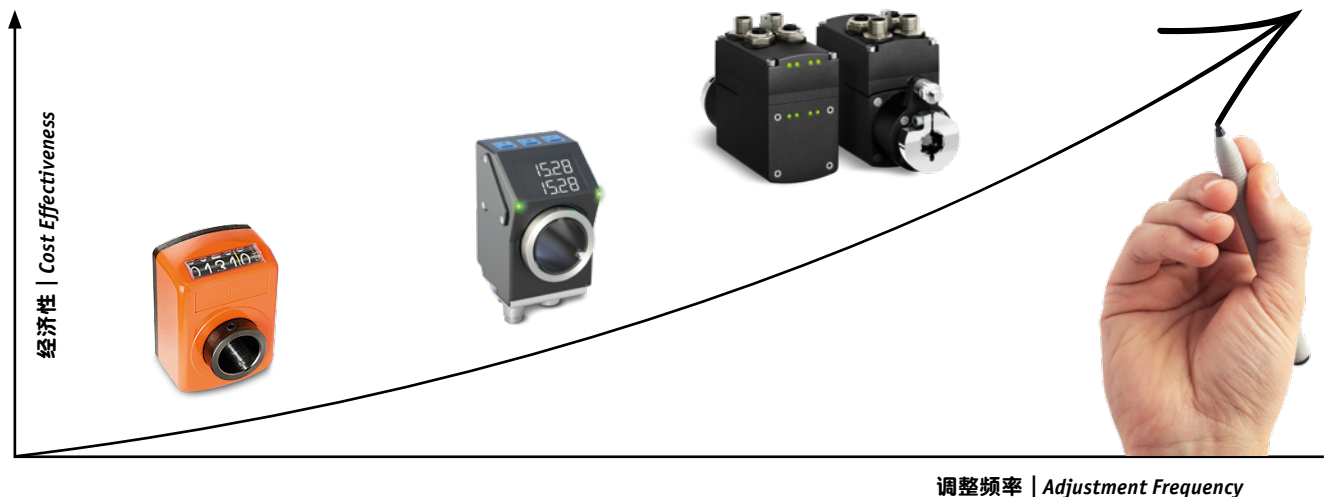

结构符合容性

SIKO 位置显示器 DA09S、AP05、AP10 和紧凑型执行驱动器 AG05、AG06 可以相互组合并进行安装互换（构体增添兼容性）。

作为机器制造商，这具有很大的优势！您可以根据客户要求，相应配置功能，提供不同的机器自动化程度。如建议，为经常要调整的轴，配备紧凑型执行驱动器；为不需经常进行调整的轴，使用经济的位置显示器进行定位。

Retro-Fit 更新改造也随时可以进行，因具备以下特征：三个设备都具有相同的空心轴直径和几乎相同的配装结构轮廓。

Compatible mounting dimensions

The DA09S, AP05, AP10 SIKO position indicators and the compact AG05, AG06 actuators are combinable and mechanically interchangeable (compatible mounting dimensions).

This means an enormous advantage for you as a machine manufacturer! You can configure the automation level of your machine individually and offer your customers a solution to suit their wishes. Our compact actuators are ideal for installing on axes which need frequent adjustment, while low-cost position indicators can be used to position axes which rarely need adjusting.

Retrofitting is also possible at all times. The crucial point: All three devices have the same hollow-shaft diameter and quasi identical mounting contours.

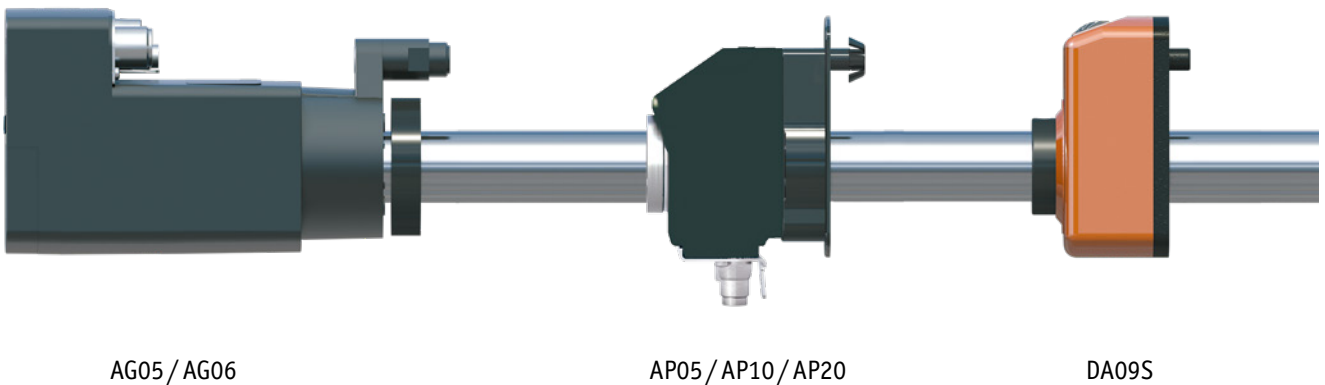

我们竭诚为您服务

无论是本地客户 ...

您正在寻找附近的代理?
我们的网站为您提供帮助, 通过
www.siko-global.com 网址和
输入邮政编码, 找到负责您的
德国 SIKO 代理商的当前联系方式。

... 还是国际客户

SIKO 公司在全球范围由子公司
和商业机构代理。
通过 www.siko-global.com
找到在您附近的 SIKO 合作伙伴。

We are always there for you.

Whether locally ...

Are you looking for an agency near you?
Our website will help you.
At www.siko-global.com you will find
current contact data of a local German
SIKO agency via your postal code.
Or just call us and we will give you the
contact data you need.

... or internationally.

Subsidiaries and agents all over the
world represent SIKO.
At www.siko-global.com you will
also find a SIKO partner in your area.



SIKO Global



SIKO GmbH



SIKO Products Inc.



SIKO Italia S.r.l.



SIKO MagLine AG



SIKO International Trading
(Shanghai) Co., Ltd.



SIKO Products Asia Pte. Ltd.

SIKO GmbH

Weiherrmattenweg 2
79256 Buchenbach

Am Krozinger Weg 2
79189 Bad Krozingen

Phone +49 7661 394-0
Fax +49 7661 394-388
E-Mail info@siko-global.com

www.siko-global.com

Follow "SIKO-global" and stay up to date!

